

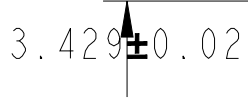

SCALE 0.750

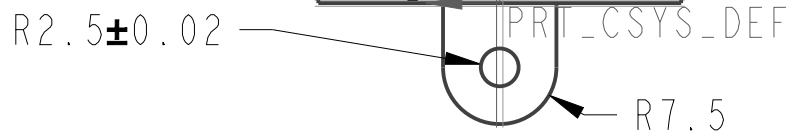
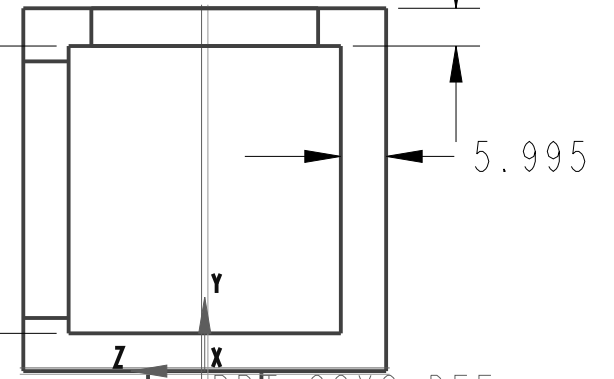
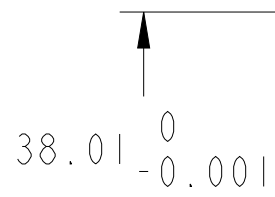
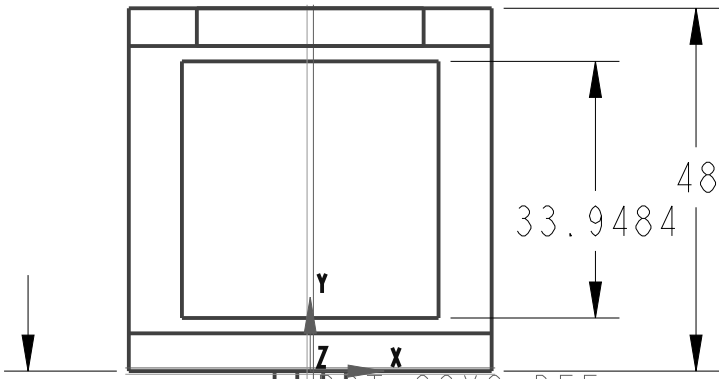
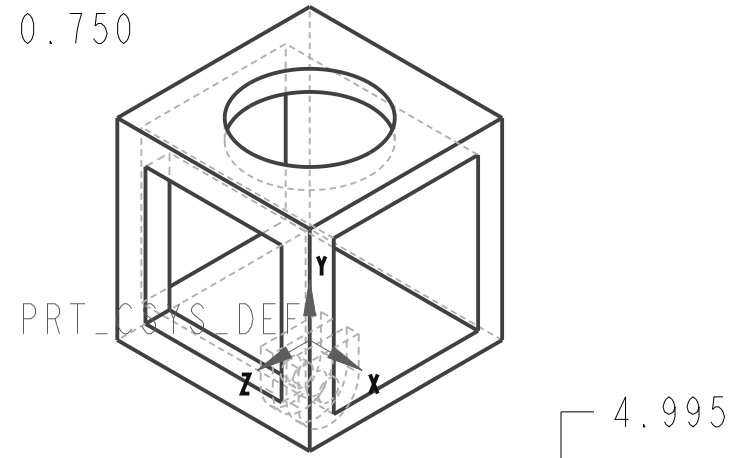

TOLERANCES		WORKING PROCESS		DATE		PART NAME	
DEC PLACES	TOLS	Machined		12/15/20		Component2	
ONE X.X	± 0.02	MATERIAL		HEAT TREATMENT		PART CODE	
TWO X.XX	± 0.01	Polymer				002	DIVISION
THREE X.XXX	± 0.005	SURFACE TREATMENT		HARDNESS		SHEET 1 OF 1	
ANGLES	± 1/2°	APPROVED	DESIGNER	SCALE	OUT OF SCALE	 UNC CHARLOTTE	
			jsmit768	1.000	YES : NO		
			CHECKED	UNIT	GT CODE		
				IN			