

The Design and Realization of the Wireless Video Monitoring System Based on Embedded Linux and CDMA1X

Yi Wu^{1,2}, Jianyong Cai¹, Xiao Lin¹
1.School of Physics and OptoElectronics
Technology,Fujian Normal University
Fuzhou 350007,China
wuyi & cji & linxiao @fjnu.edu.cn

Lianfeng Shen²
2.National Mobile Communications Research
Laboratory, Southeast University
Nanjing 210096,China
lfshen@seu.edu.cn

Abstract

With the rapid development of the mobile communication technology, multimedia transmission over mobile network has become a hotspot in the monitoring area. We propose an application of the embedded Linux system and CDMA1X wireless data transmission technology in the video surveillance system. It is also a general model of wireless video capture and transmission based on embedded Linux and CDMA1X network. By using CDMA date communications technology, H.264 digital video compressed encoded and decoded algorithm and RC4 encryption mechanisms, the system can achieve efficient collection, encoding, encryption and transmission processing of the real-time video signal. It can be widely used in public security, fire protection, transportation, finance, news gathering, and other fields.

Keywords: *Embedded Linux; CDMA1X; wireless transmission; video surveillance*

1. Introduction

Multimedia monitoring has become the most popular method in current surveillance field. Not only can it be applied in the industrial process monitoring, traffic management and control, but also in financial outlets, unattended and important location surveillance and alarming. Normally, the video signal of multimedia monitoring system contains the most abundant and useful information, and the video monitoring technology involves many scientific and technical fields, such as digital signal processing, video compression encoding and decoding, video transmission, video storage and network communications. It covers widely disciplines, requires high

technical content, and can be used in many application fields.

Currently, most of the video monitoring systems are based on fixed surveillance, have no mobility and are subject to the hardware and the connections of transmission line, which are unable to meet the special need of the industry, such as the mobile monitoring of the police patrol car, the real-time video transmission of the news gathering and the banknote delivering of the security companies, the surveillance of the unduty locations in the factories and warehouses, and other real-time monitoring situations.

The mobile monitoring technology based on the wireless communication network, can meet the needs mentioned above very well. With the great development of wireless communication technology and the popularity of Internet, the capture and compression of the real-time living video, and the long-distance wireless transmission technology become important research topics in the field of wireless communication and computer science. Wireless accessing based on the existing mobile communication technology which concludes GSM network, GPRS network and CDMA1X network is a useful supplement to the wired network. By using wireless channel, the transmission of voice, data and video can be achievable. Furthermore, Wireless network has the advantage of mobility, in the range covered by the mobile communication network, devices can connect to Internet at anytime and anywhere, do not care about the limits of cumbersome cable and the complex factors of the geographical topography and location, and the network can extend to the places where the cable network is inaccessible, and also the costs of maintain and implement of such network are low.

Embedded system based on the computer technology and focused on the application, is a special computer system. The hardware and software of embedded system can be cut and adapted to applications. Due to more strict requirements to some factors such as functionality, reliability, cost, size and power consumption, it has high reliability so that it can normally work in poor conditions or in the case of suddenly

This work was supported by The Technology and Research Project of Fujian Province, China (No. 2005H026) and The Research Project of Fujian Education Government (No. JA06006)

power off. It also has high real-time character, and has the capabilities of real-time processing in some complex applications.

Currently, there are many applications of video transmission which are based on the embedded system [1]-[5]. Reference [1] developed an embedded adaptive live video streaming transmission system on GPRS/CDMA network based on MPEG4 video compression standard. The system presents a performance enhancement for real-time video transmission by employing an adaptive sender rate control scheme, which estimates the available channel bandwidth between the sender and receiver, then adjusts the output rate of encoder side using R-D framework and frame-skip control mechanism according to the estimated time-varying channel bandwidth. Reference[2] investigated an embedded multicast/broadcast approach for transport of digital video over spread-spectrum code-division multiple access (CDMA) cellular networks and provided a cross-layer approach incorporating adaptive power allocation and channel coding strategies and effectively match a discrete cosine transform based scalable motion-compensated video encoder to an embedded multi resolution modulation scheme to simultaneously deliver a basic quality-of-service (QoS) to less capable receivers while maximizing both the QoS for more capable receivers and the system capacity. Reference[3] presented the eMeeting prototype system which can implement the H.263 video encode and decode and bidirection communication on one XScale PXA255 general embedded processor. Experiment results show that the eMeeting system can achieve the frame rate up to 8fps under the circumstances that the encoding, decoding, network communication, video capturing and other modules are ongoing simultaneously.

This paper presents a method applying the embedded technology in wireless video transmission, and develops a real-time video surveillance system based on the CDMA1X network. The system can be used as a general model which is based on embedded Linux and CDMA1X wireless video capture and transmission, applying CDMA data communication technology, H.264 digital video compression encoding and decoding algorithm and RC4 encryption mechanisms. It can realize the efficient collection, encoding, encryption and transmission processing of long-distance real-time video signal.

2. Overall design of the system

The network topology of Wireless Video Surveillance System is shown in figure 1. The system contains two major components—the remote monitoring equipment and the local monitoring terminal.

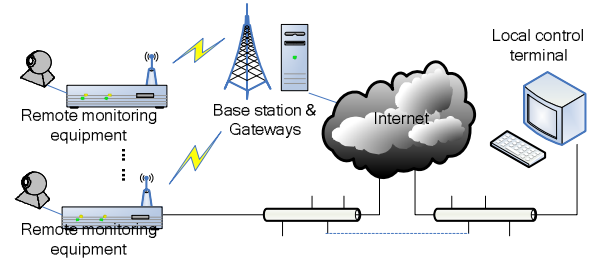

Figure1. Topology of the remote wireless video monitoring system

The remote monitoring equipment based on the design of ARM embedded system sends the captured and compressed video data to the designated local control terminal, through the appropriate network communication links.

The local control terminal is a network host installed the client software. It controls the remote monitoring equipments and decrypts, replays, saves and manages the video data received from the remote equipment.

There are two types of network communication links between the remote monitoring equipments and the local control terminal. One is the Ethernet connection and the other is the CDMA cellular network. In our research works, we focus on the video transmission over CDMA1X network. Considering the limited bandwidth of CDMA1X network, the remote monitoring equipments are designed using two CDMA1X modules to transmit the video data so as to enhance the transmission efficiency. However, the design of the video transmission mechanism over two separated CDMA channels is a big challenge. In section 3, we present a novel multilink scheduling poll mechanism to realize real-time video transmission over CDMA1X network.

2.1 Hardware design of the remote monitoring equipment

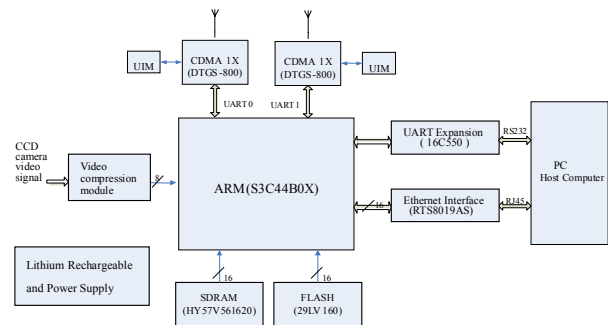

Figure 2. Block diagram of the remote monitoring equipment hardware

The hardware platform of the remote monitoring equipment mainly includes video compressed module (JM718M), ARM7 processor (S3C4B0X), Flash and

SDRAM, CDMA communication module (GTS-800) and Ethernet interface (RTL8013AS). The block diagram of the system components is shown in figure 2.

Firstly, the video data which are captured by the CCD camera are encoded by H.264 video compression module and are transformed into the H.264 signals. The H.264 signals are buffered and processed by the ARM processor in the way of 8-bit data bus. Then the processed data are sent to the CDMA module through the serial interface and modulated and transmitted by the CDMA module.

Video compressed module—JM718M is selected. Taking into account that the tremendous computing tasks of the video compression and large consumption of the CPU resource in the case of using the microprocessor to process the video signals in sampling and compressed encoding, the specialized hardware chip is selected for video processing. JM718M compresses the data from CCD camera into H.264 signals which are output in 8-bit data buses.

ARM embedded processor module—It is the core of the hardware, S3C44B0X chip manufactured by Korea SAMSUNG Company is selected. The ARM has inner TCP/IP protocol stack, and the embedded web server can be established in S3C44B0X by using HTTP protocol, the computer can also use the Internet explorer to visit ARM through IP address.

CDMA module—DTGS-800 are selected as the dedicated CDMA1X modules. Through RS-232 interface, the video data are sent to the CDMA cellular networks. In consideration of the transmission rate of the current CDMA uplink, a single piece of DTGS-800 can not meet the requirement. To improve the expansibility and universality of the data transmission module, we select two pieces of DTGS-800 module; under the control of the ARM processor, the multi-channel scheduling strategy based on wireless channel transmission quality which is presented in our research work are applied to achieve higher speeds and transmission quality.

Ethernet interface— RTL8019AS is used to complete the communication and data transmission.

RS232 interface— Two UART interface, UART0 and UART1, are respectively communicated with two pieces of CDMA module for data and video transmission.

In the process of data transmission, it loads a piece of SDRAM (HY57V561620: 4banks × 4M × 16=256M bit) to buffer the throughput of the cache data and a piece of FLASH (MBM29LV160: 1M×16bit = 16M bit) to load and store the program.

2.2 Software design of the remote monitoring equipment

The software architecture of remote monitor equipment is divided into three layers—the application layer, the

operating system layer and the hardware abstract layer. It is shown in Figure 3.

Hardware abstract layer—It is composed by various drivers. The CDMA module of the monitoring equipment communicates with the controller through a serial port, and the monitor equipment communicates with the PC through the Ethernet interface, with the H.264 compression board through the SIO port.

The operating system layer—The uClinux system is selected which is developed for non-MMU processor and has powerful network capabilities. It is composed of some related software, such as memory management, process scheduling, file system and network protocol stack, etc.

The application layer— It is above the OS layer, composed of data encryption, data decryption, data reorganization, data transmission receivers, CDMA module management and transmission control, etc.

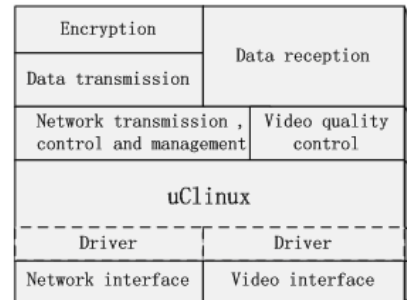

Figure 3. Software architecture of the remote monitoring equipment

2.3 The design of the local control terminal

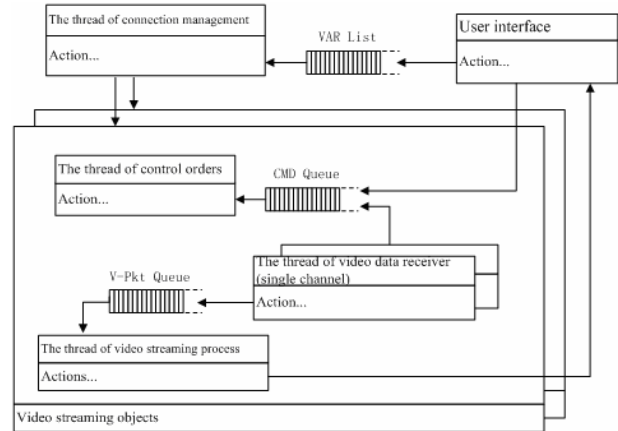

Figure 4. Threading module of the local monitoring client terminal

The local terminal is designed in multi-threading and improved RTP model. The threading model is shown in figure 4, which is a cooperating design under the control of

the multi-threading management, accessing the improved RTP network interface. In the view of the load of the network, a local client is allowed to control the maximum of four remote monitoring equipments at the same time.

2.4 The realization of the data communication between the remote monitoring equipment and the local monitoring terminal

The remote monitor equipment uses two pieces of CDMA modules for video transmission. After the successful dial-up of the CDMA modules, each module gets a CDMA IP address. When it communicates with the local monitor, there are two circumstances, one is the monitor using a static IP address, and the other is the receiver using a dynamic IP address. There are also two cases of communication to discuss respectively, as follows:

a) Using the static Internet IP address in the local monitor

The local monitoring terminal has a fixed Internet IP addresses as shown in figure 5.

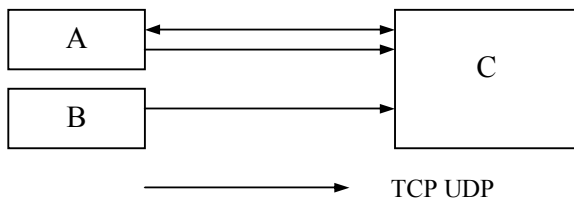

Figure 5. Communication between the remote monitoring equipment and the local monitoring terminal (the receiver has a static IP address)

The communication processes are as follows:

- The remote monitoring equipment establishes communication links through the CDMA modules A and B with the remote receiver C which has a fixed IP address;
- Receiver C sends the control commands to the remote monitor module A and B to start the video transmission;
- Sender modules A and B send video data to the receiver module through the use of multi-channel mechanism;
- In the process of communication, C gives A the feedback information of the channel conditions for rate control.

b) Using dynamic Internet IP address in the local monitor

When the local monitoring terminal uses dynamic IP address, it applies two types of methods in communicating with the remote monitoring equipment. One is the dynamic IP address resolution by the DNS server; the other is using the short message to tell the dynamic IP address of the receiver to the remote monitoring equipment. The brief

introductions of the implement of these two methods as follows:

The address resolution method: The DNS server is applied to resolve the dynamic IP address in the between of the remote monitoring equipment and the local monitoring terminal. As shown in figure 6.

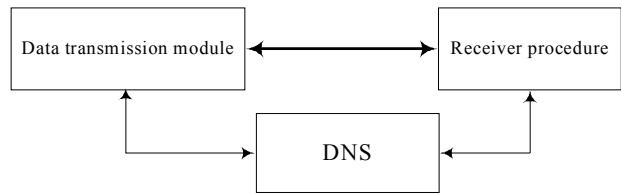

Figure 6. Resolution of the IP Address

The communication processes are as follows:

- The remote monitoring equipment gets the IP address of the receiver through DNS resolution;
- Establishing the TCP communication links between the remote monitoring equipment and the receiver;
- The receiver sends the control commands to the remote monitoring equipment to start the video transmission;
- The remote monitoring equipment sends the video data to the receiver;
- In the process of communication, the receiver sends the feedback information of the link conditions to the sender for rate control.

The SMS method: Although the IP address obtained by the wireless modem is dynamic, the telephone number of the bundled UIM card is fixed in the process of the CDMA wireless communication. So by virtue of the short message service, the remote equipment and the local receiver can communicate each other.

2.5 The receiver interface of the remote wireless video transmission system

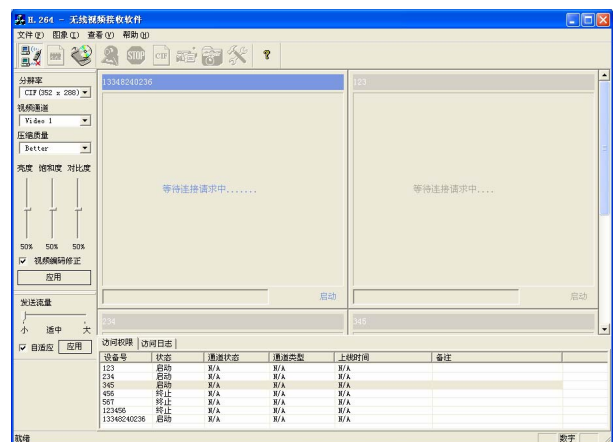

Figure 7. Interface of the local control terminal

Using the design above, the monitoring interface of the local monitoring terminal is shown as figure 7. The client terminal has some functions such as the video playback, video storage, video capture, video quality control and link management, etc.

3 Multilink scheduling poll mechanism

In order to improve the actual output, multilink parallel transmission method is used in this system. By using multilink transmission the sending data is distributed and the payload of single link is reduced which benefits to congestion avoiding. The bandwidth is also increased by using multilink which means the sending rate could be increased to load higher video compressed quality and improve the replaying quality. But along with the payload of the link increasing the risk of congestion are also increased. So, a balanced select method between the congestion and payload is needed.

In the design of multilink scheduling poll mechanism we has emphasized particularly on the maintaining of link transmission quality, each link maintains a normal sending rate (50%~80% of the channel actual sending rate). With the cooperating work of multilink, the sending rate is increased. Due to the ability of network self-restoring, lower sending rate could reduce the probability of congestion. The procedure of multilink cooperating working is shown in figure 8. In the ideal situation, if the poll mechanism is good, multilink parallel transmission can be used to improve the sending rate.

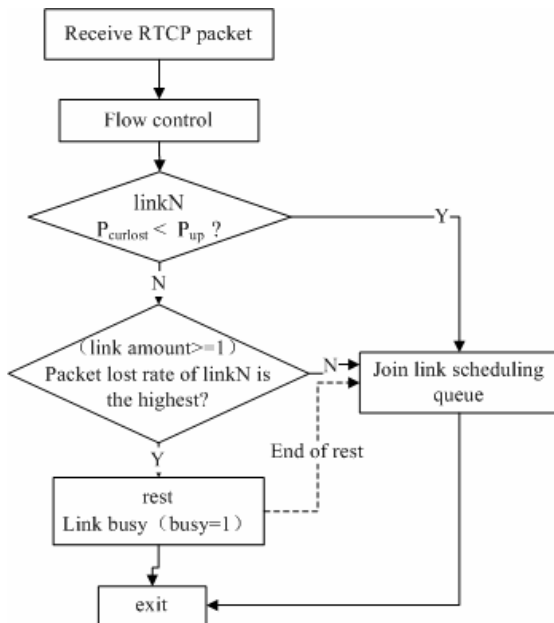

Figure 8. Procedure of multilink scheduling poll

When several links joins the link scheduling queue, the transmission starts. The procedure of transmission is shown in figure 9.

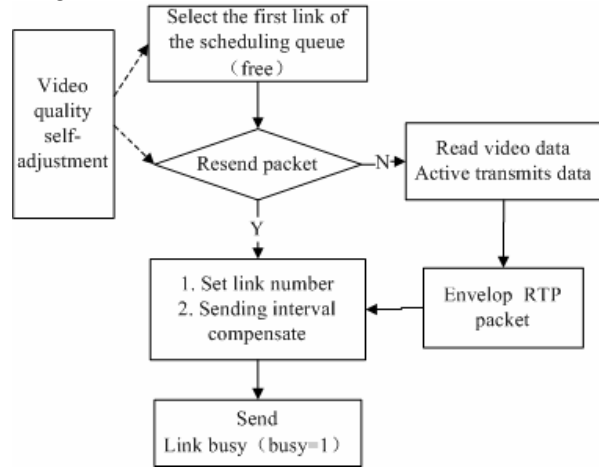

Figure 9. Procedure of transmission

4. Simulation experiments and conclusion

The simulation test result of video quality of double transmission channels is shown in table 1.

Table 1. Simulation test result of video quality

Test time	Last time	Receive frame rate(f/s)	Transmit rate (Kbps)	Packet lost rate of link 0	Packet lost rate of link 1
2007-4-12 10:00	30 min	5.3~8.1	60~80	2.16%	2.01%
2007-4-17 10:00	62 min	4.7~7.8	58~80	2.57%	2.11%
2007-4-18 10:00	35 min	4.9~7.8	60~80	2.13%	2.25%

Applied by the mechanism we propose in this paper, the transmission rate of double links steadied at 58Kbps to 80Kbps, receiving frame rate from 4.7f/s to 8.1f/s. The transmission rate is higher than that of the single link. And the stable receiving frame rate improves the replay quality.

References

- [1] Zhixiong Liu, Guiming He. An embedded adaptive live video transmission system over GPRS/CDMA network. Proceeding of the Second International Conference on Embedded Software and Systems, 2005.
- [2] Chan, Y.S. Modestino, J.W. Qu, Q. Fan, X. An end-to-end embedded approach for multicast/broadcast of scalable video over multiuser CDMA wireless networks. IEEE Transactions on Multimedia, 2007(9):655-667
- [3] Tao Pin; Cui Peng. eMeeting: the implementation of H.263 based embedded video communication. IMACS ulticonference

- on Computational Engineering in Systems Application, Oct. 2006 pp:1197-1201
- [4] Wilberg, J.; Camposano, R.; Westerholz, U.; Steinhausen, U. Design of an embedded video compression system-quantitative approach. Proceedings. ICCD '94. IEEE International Conference on Computer Design: VLSI in Computers and Processors, 1994. pp:428-431
- [5] Lehtoranta, O.; Kukkala, P.; Hamalainen, T.D.; Lappalainen, V. Implementation of a video transcoder for embedded system. Proceedings. ITCC 2003. International Conference on Information Technology: Coding and Computing [Computers and Communications], 2003.PP: 389-395