

Multifunctional Intelligent Autonomous Parking Controller for Carlike Mobile Robots



Tzoo-Hseng
S. Li



Ying-Chieh
Yeh



Jyun-Da Wu



Ming-Ying
Hsiao

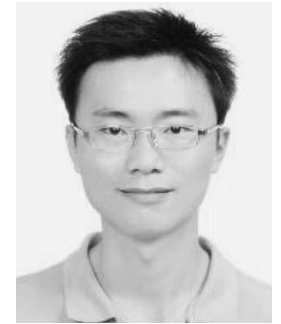

Chih-Yang
Chen

Presented by: Riju Kuruvila
ECGR 6185 Advanced Embedded Systems
13th March 2013



Outline

- Introduction
- Ultrasonic Sensors
- Behavior Modes
 - Fuzzy Parallel-Parking Mode
 - Fuzzy Garage-Parking Mode
- Architecture
- Experimental Results
- Conclusion
- References

Introduction

- Designed for Carlike Mobile Robot (CLMR)
- Autonomous Parking and Obstacle Avoidance
- Array of ultrasonic sensors

Ultrasonic Sensors

- Arrangement

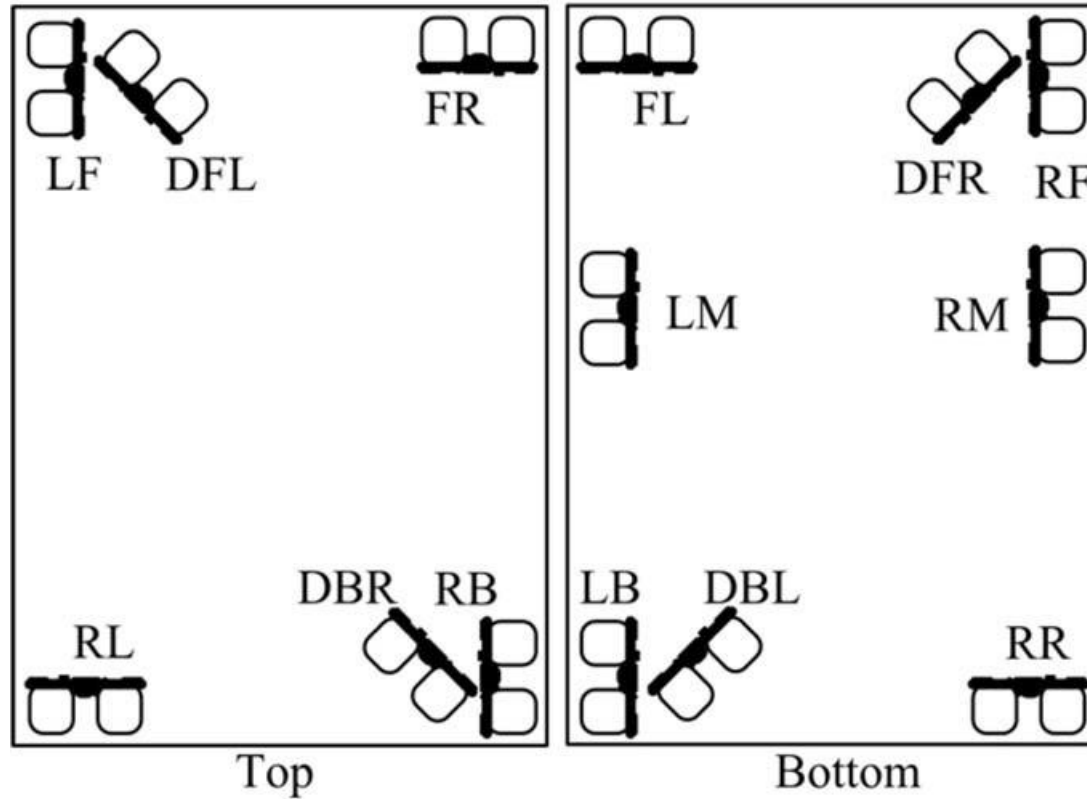

[1]

Ultrasonic Sensors

- Firing Sequence

Sequence 1

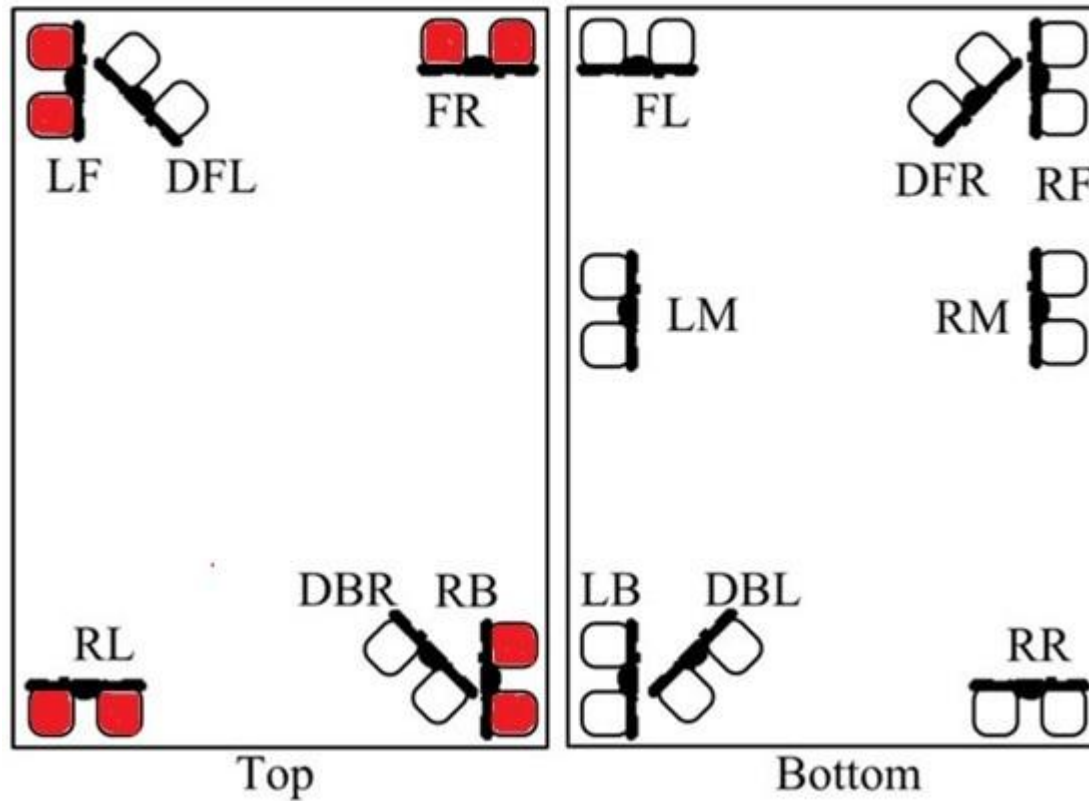

Ultrasonic Sensors

- Firing Sequence

Sequence 2

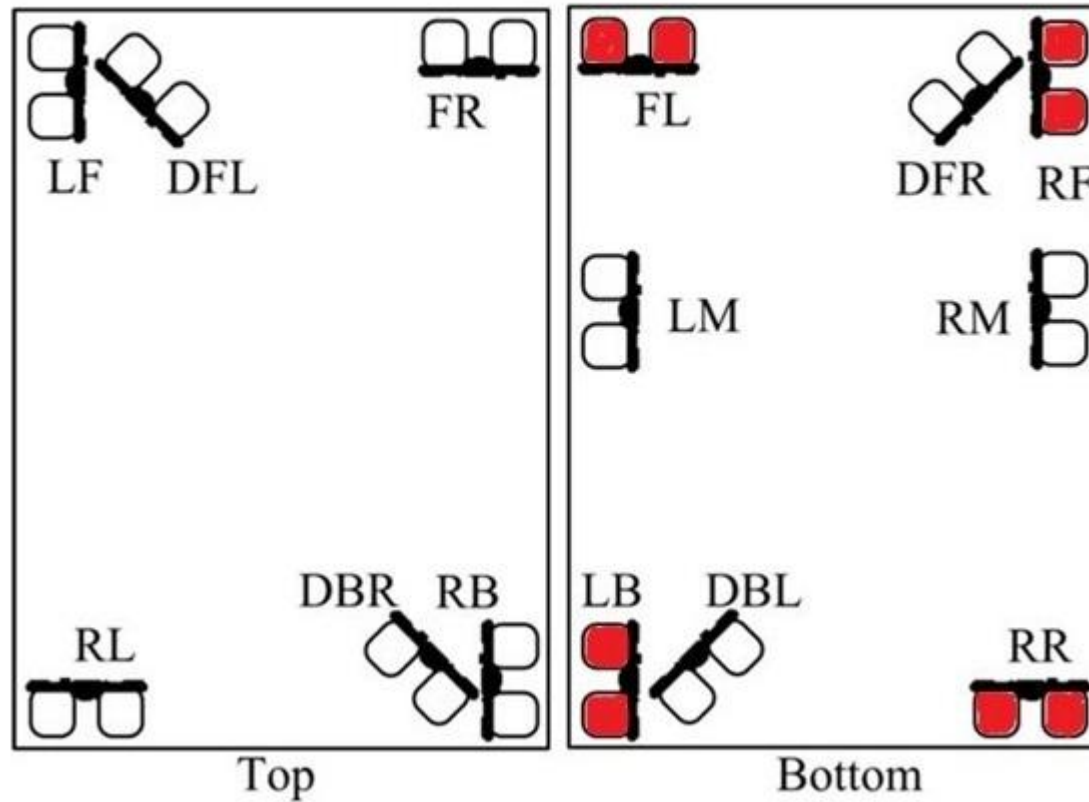

Ultrasonic Sensors

- Firing Sequence

Sequence 3

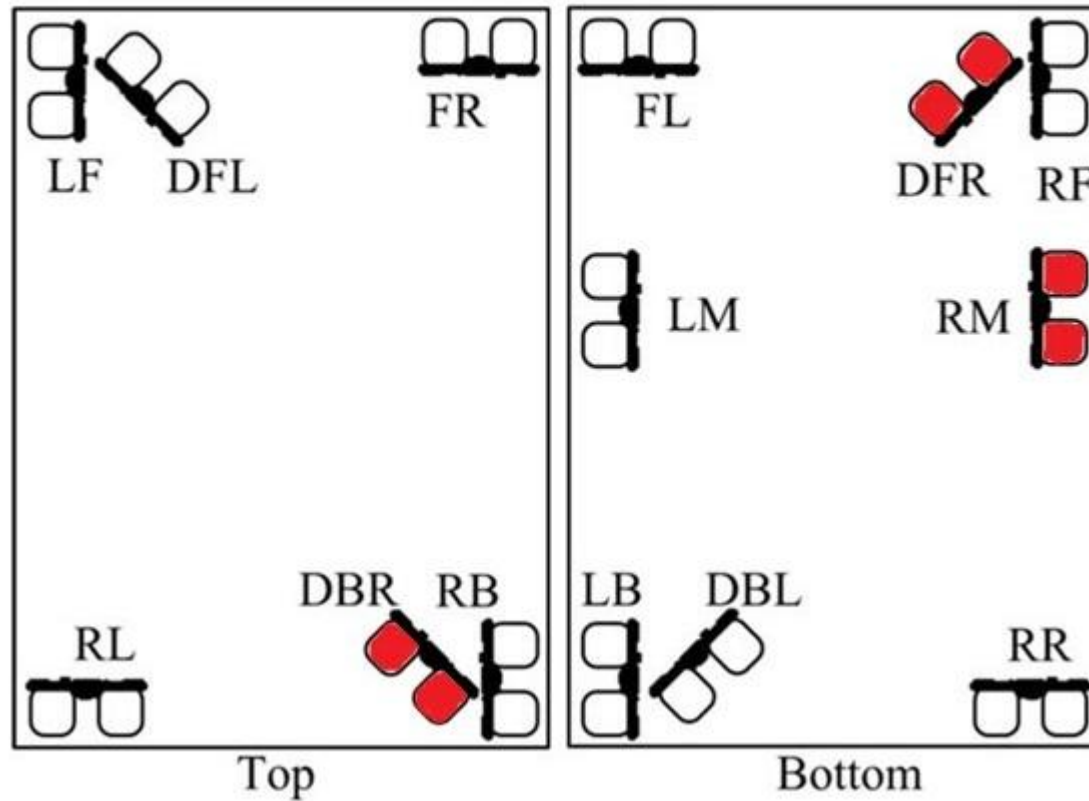

Ultrasonic Sensors

- Firing Sequence

Sequence 4

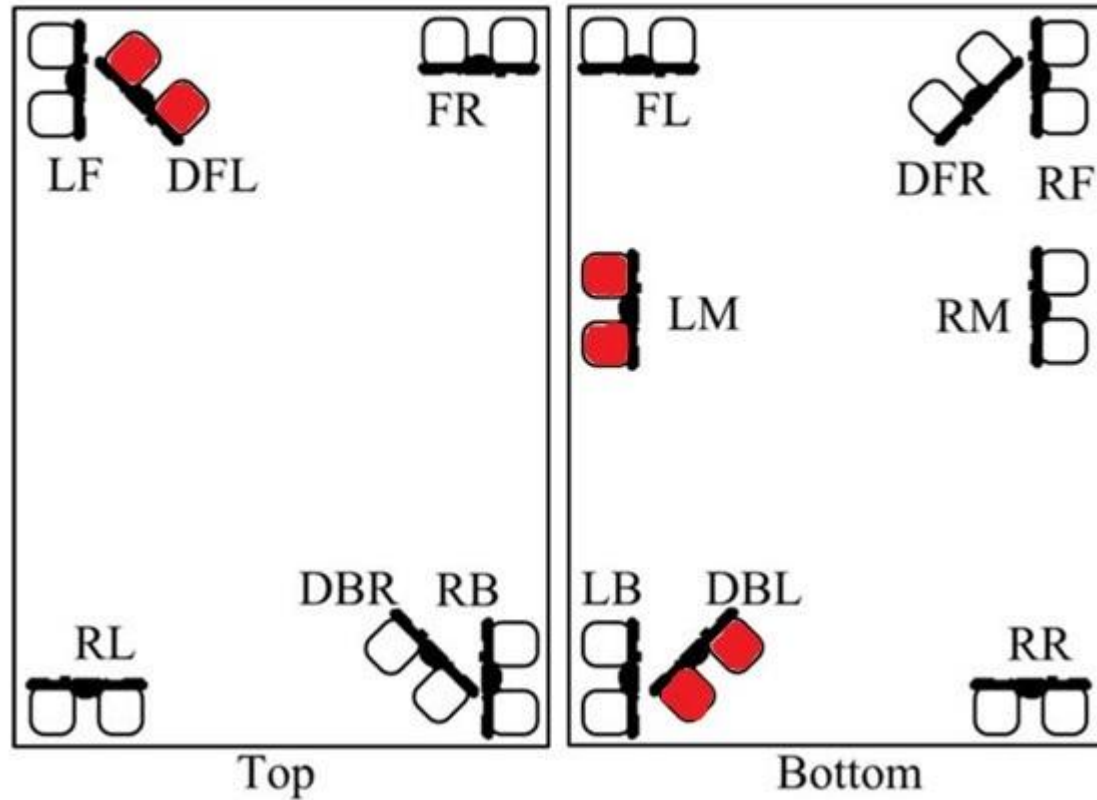

Ultrasonic Sensors

- Firing Sequence

Sequence 5

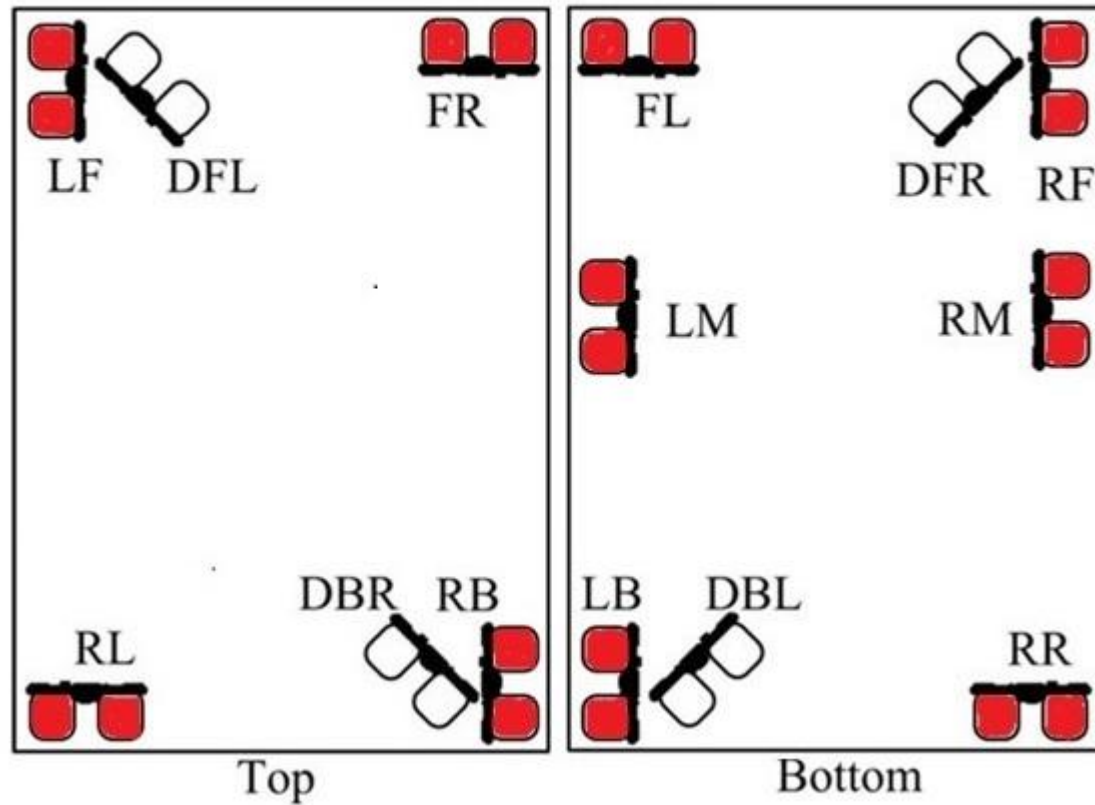

Determination of Reflector Position

$$x = A \cos(\alpha) \cos(\phi) - B \sin(\alpha) \sin(\phi) + x_{tr}$$

$$y = A \cos(\alpha) \sin(\phi) + B \sin(\alpha) \cos(\phi) + y_{tr}$$

Where,

$$\phi = \arctan((y_r - y_t)/(x_r - x_t)),$$

$$A = L/2,$$

$$B = ((L^2 - d_{tr}^2)/2)^{1/2},$$

$$d_{tr} = ((x_r - x_t)^2 + (y_r - y_t)^2)^{1/2}$$

$$x_{tr} = (x_r + x_t)/2$$

$$y_{tr} = (y_r - y_t)/2$$

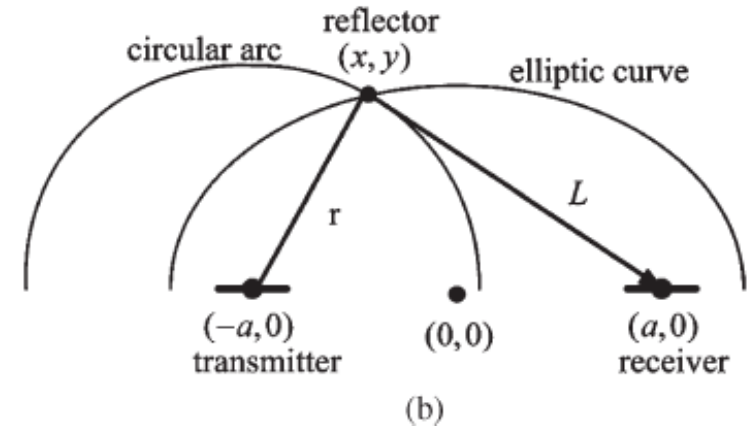
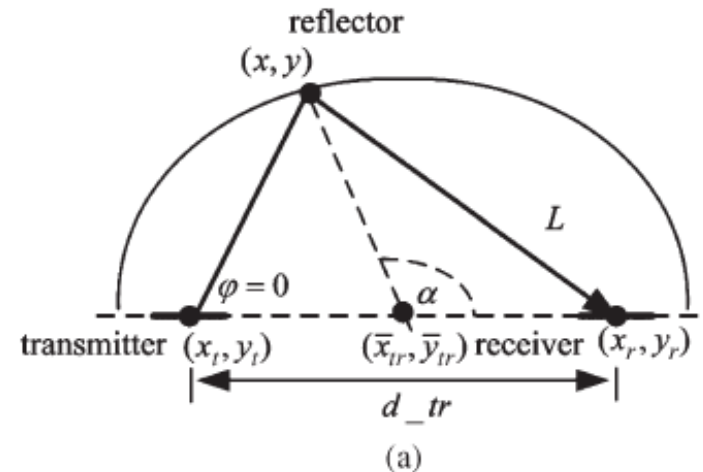

[1]

Determination of Types of Reflectors

1. Multichannel Method

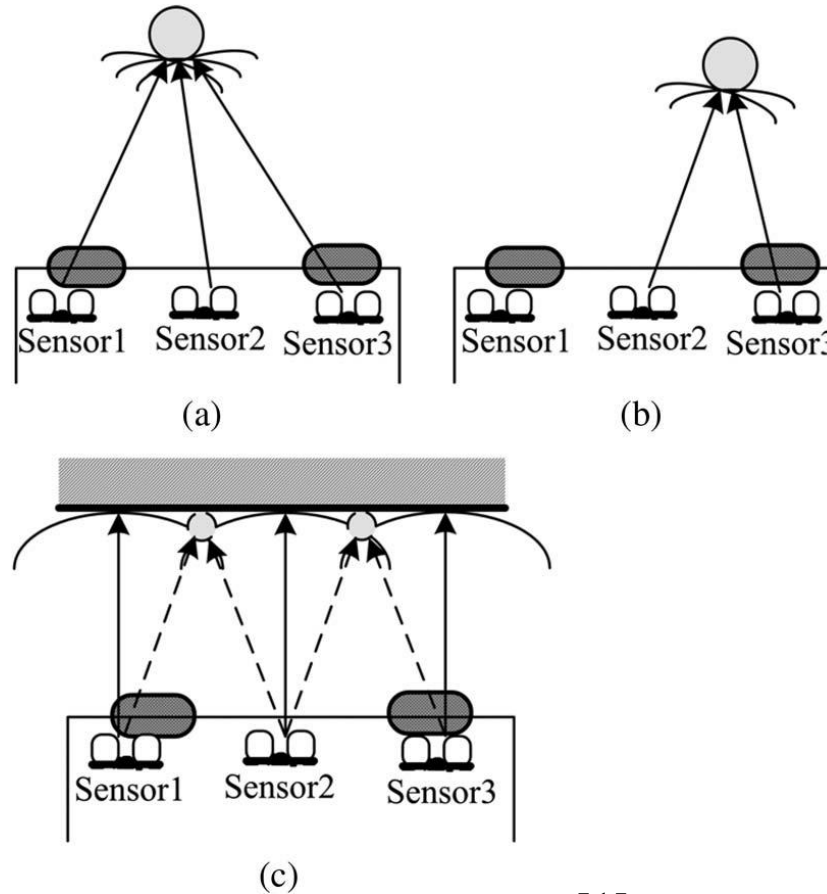

[1]

Determination of Types of Reflectors

2. Displacing Position Method

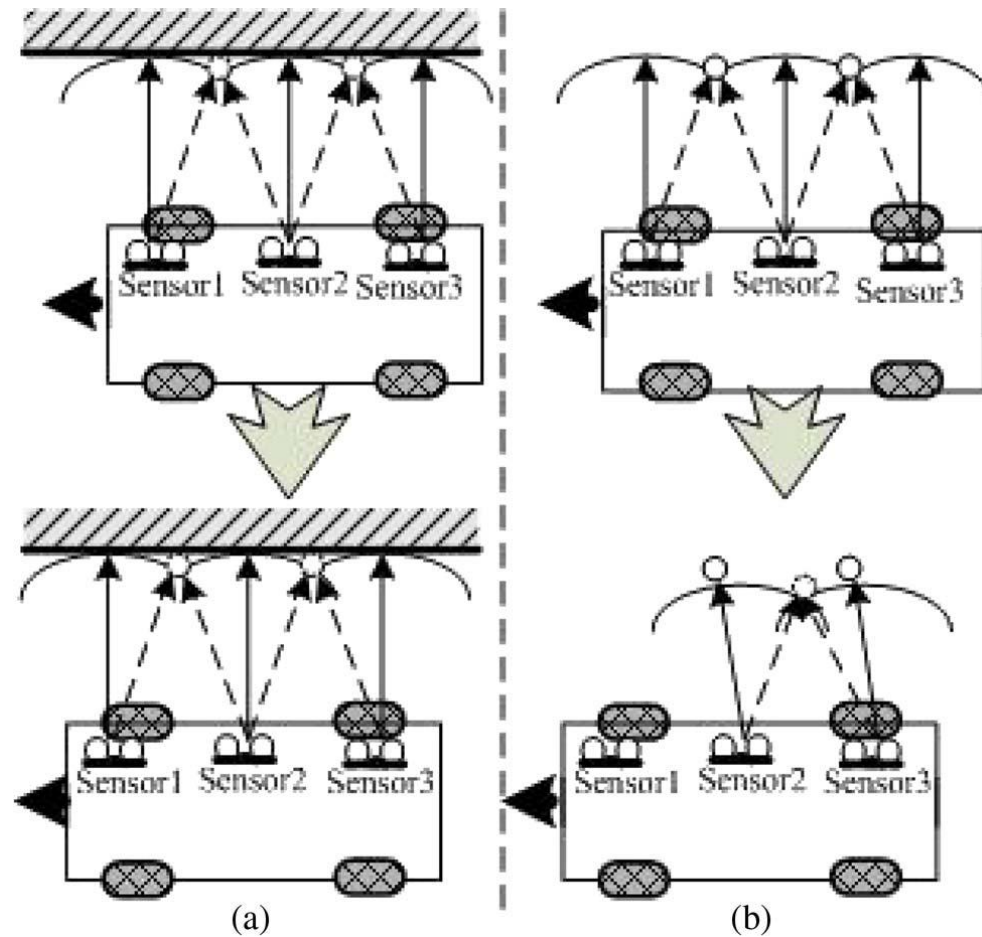

[1]

Behavior Modes of CMLR

- Fuzzy Parallel Parking Mode

- Basic Constraints:

$$(1.2W < d_{rf} < 1.5W)$$

$$(1.35L < d_f < 1.75L)$$

$$(1.6L < d_{dfl} < 2.2L)$$

Where,

W → Width of CLMR

L → Length of CLMR

d_{rf} → Distance detected by RF

d_f → Distance detected by FR

d_{dfl} → Distance detected by DFL

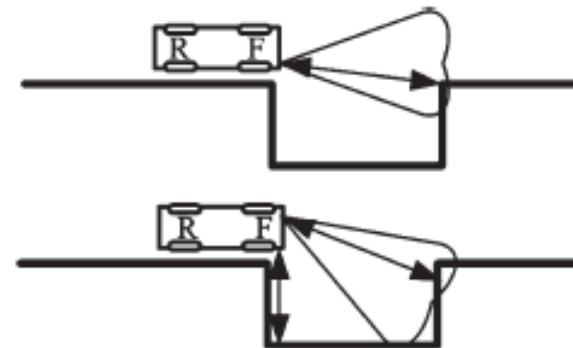
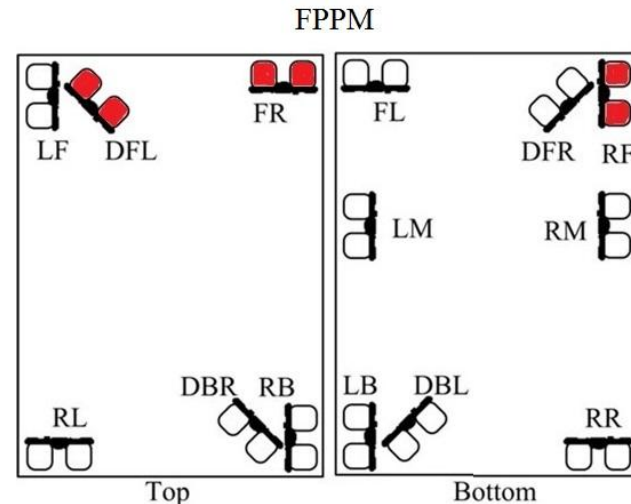

[1]

Fuzzy Parallel Parking Mode

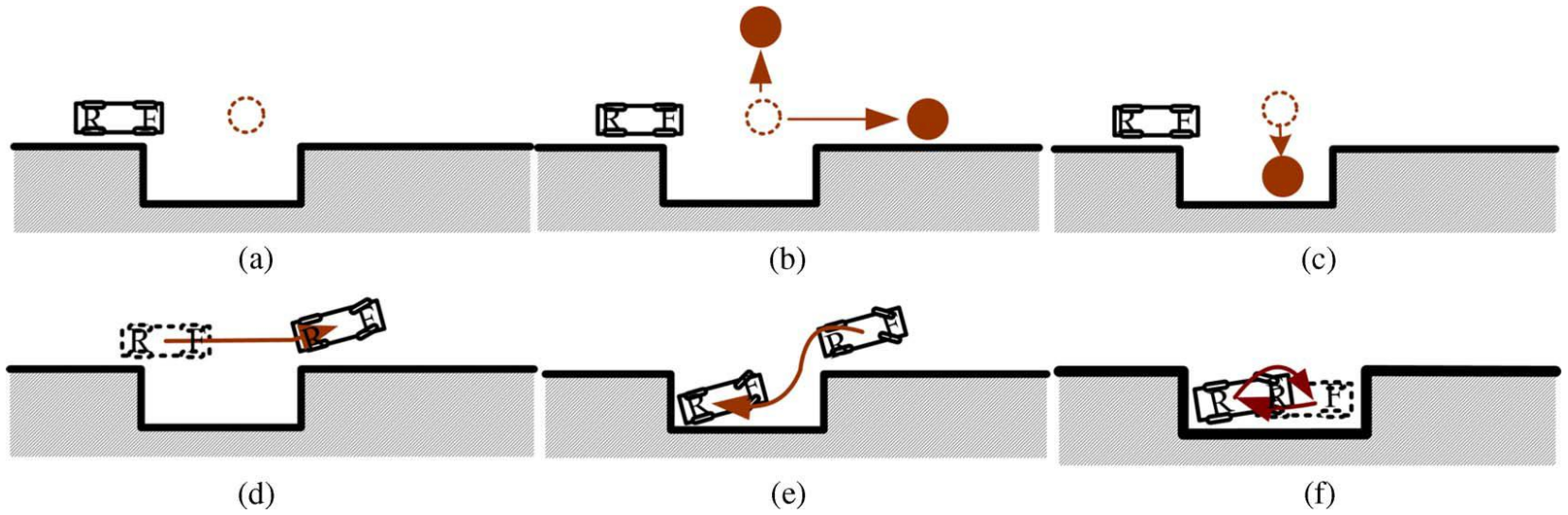

[1]

Fuzzy Parallel Parking Mode

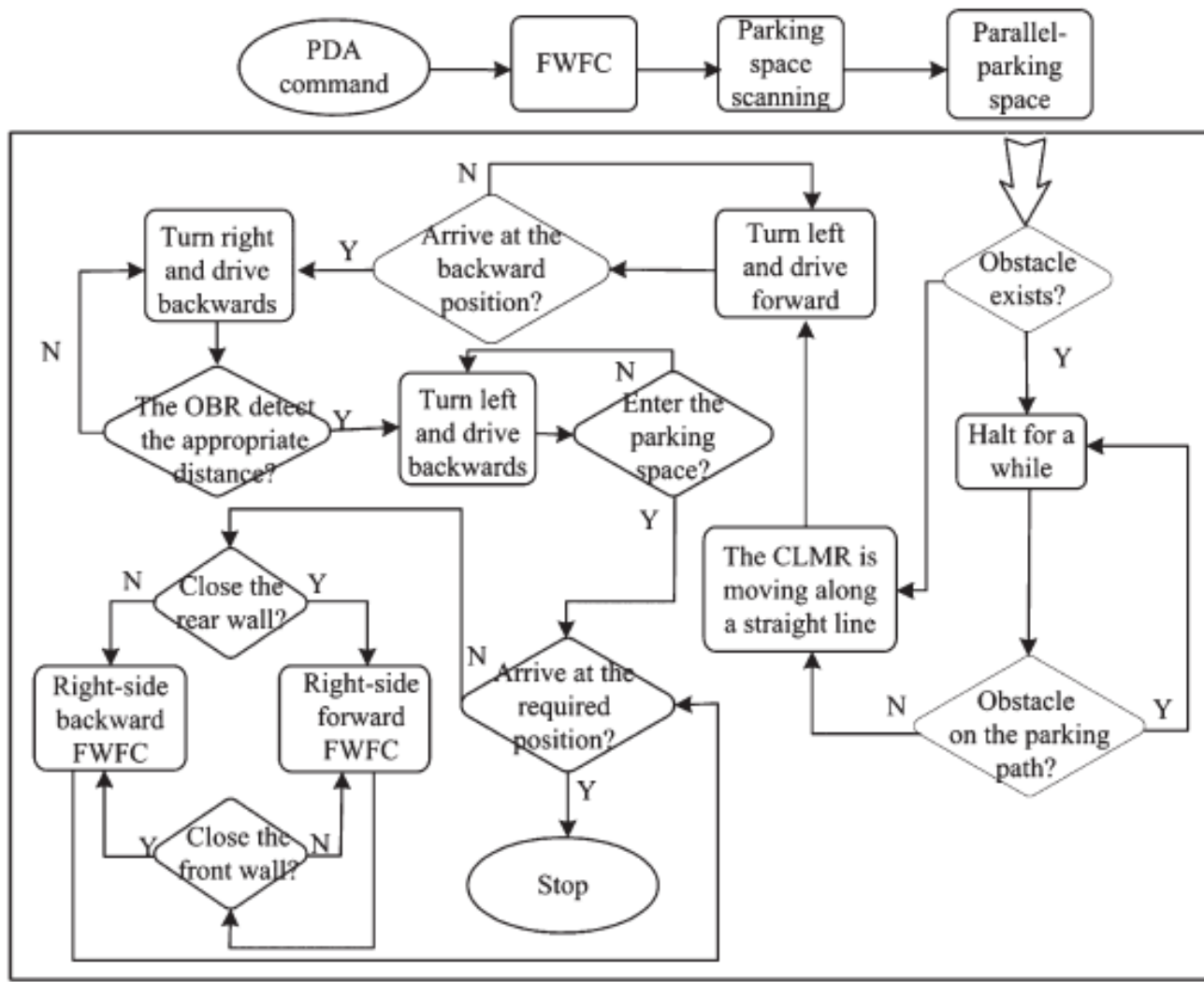

[1]

Behavior Modes of CMLR

- Fuzzy Garage Parking Mode

- Basic Constraints

- $(1.4L < d_{rf} < 1.8L)$

- $(1.8W < d_f < 2.4W)$

- $(1.4L < d_{rm} < 1.8L)$

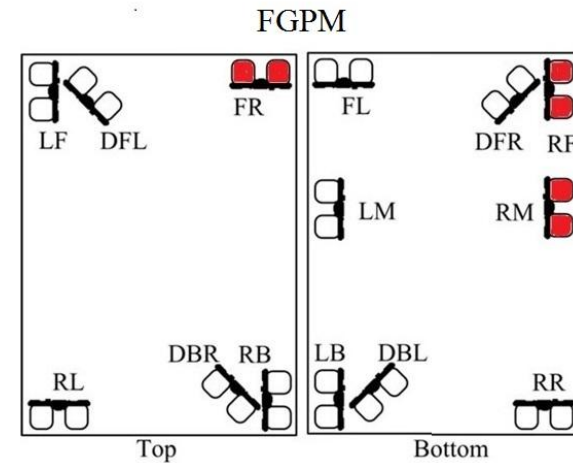

Where,

$W \rightarrow$ Width of CLMR

$L \rightarrow$ Length of CLMR

$d_{rf} \rightarrow$ Distance detected by RF

$d_f \rightarrow$ Distance detected by FR

$d_{dfl} \rightarrow$ Distance detected by DFL

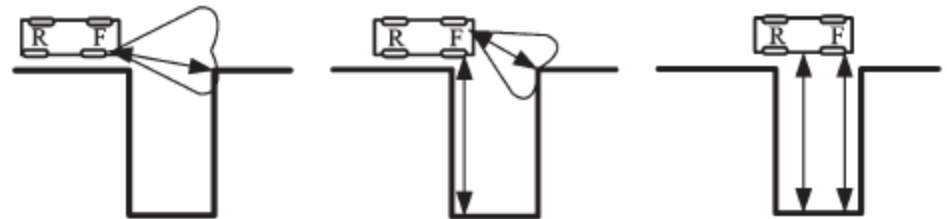

[1]

Fuzzy Garage Parking Mode

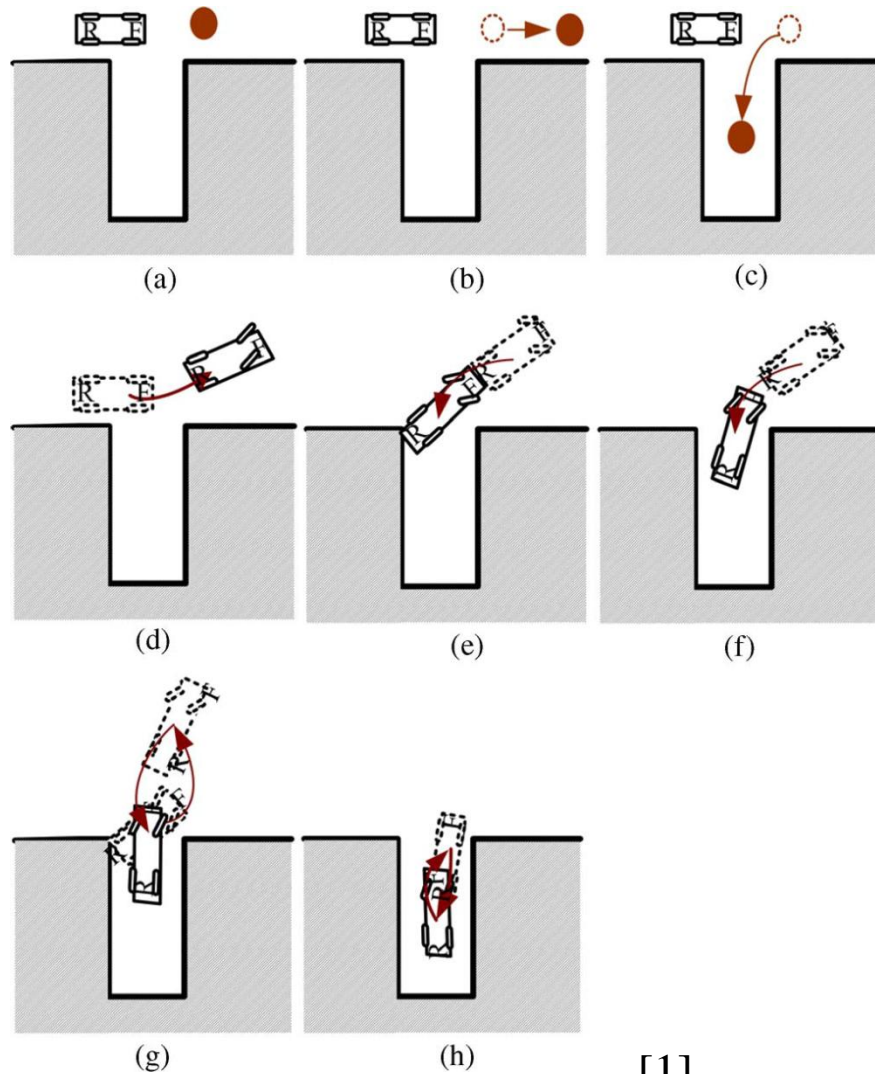

[1]

Fuzzy Garage Parking Mode



[1]

NIOS Embedded System

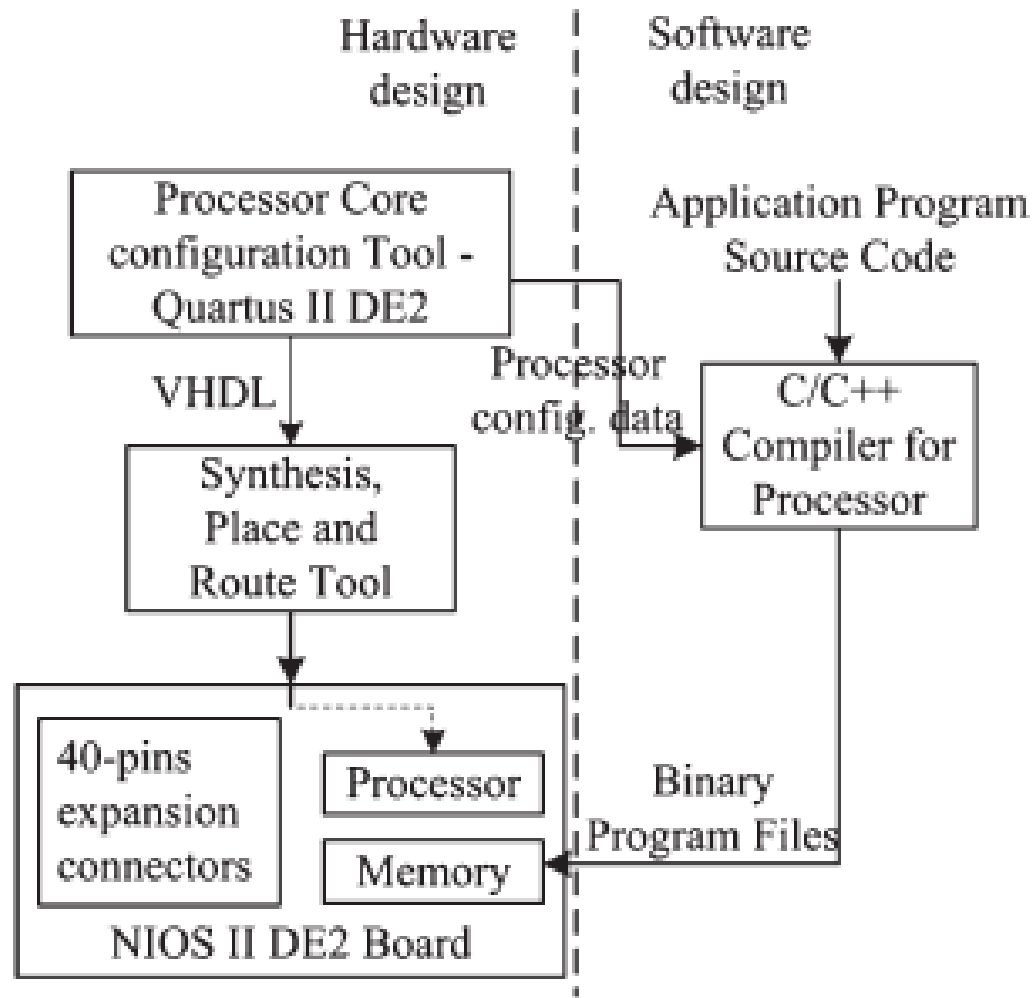

[1]

Experimental Results

1. FPPM



2. FGPM



[1]

Conclusion

- Multifunctional intelligent autonomous parking controllers of CLMR implemented using NIOS-embedded systems
- Autonomous parking controller capable of effectively parking CLMR in parking space has been developed
- It can recognize parking space and obstacle's position to ensure safe autonomous parking

References

1. Tzoo-Hseng S. Li, Ying-Chieh Yeh, Jyun-Da Wu, Ming-Ying Hsiao, and Chih-Yang Chen, "Multifunctional Intelligent Autonomous Parking Controllers for Carlike Mobile Robots", Industrial Electronics, IEEE Transactions on Volume: 57 , Issue: 5